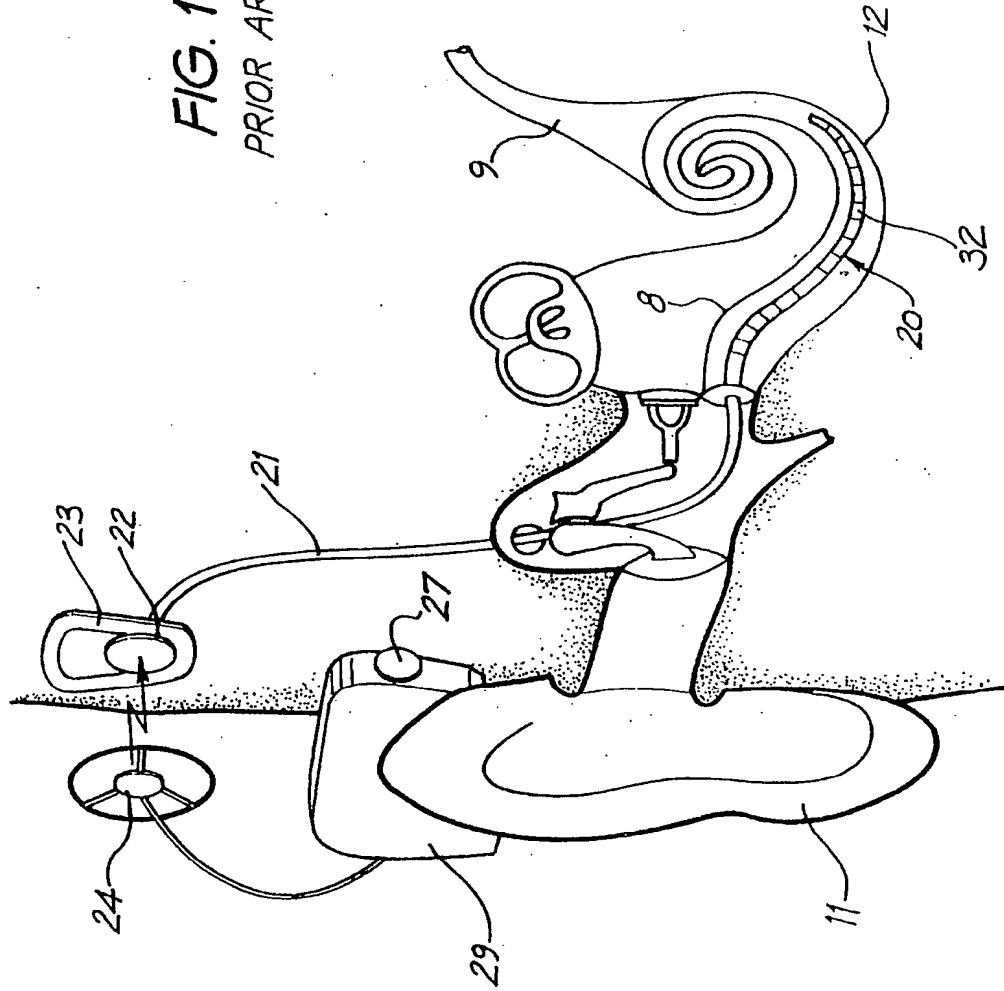
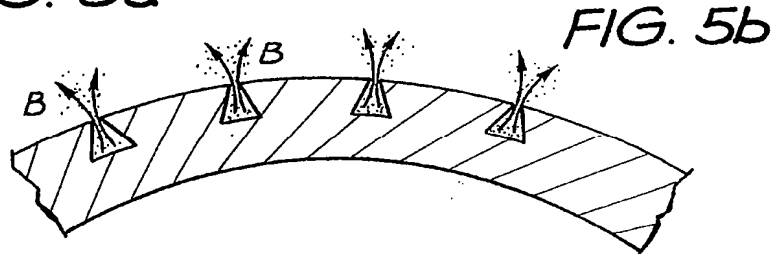
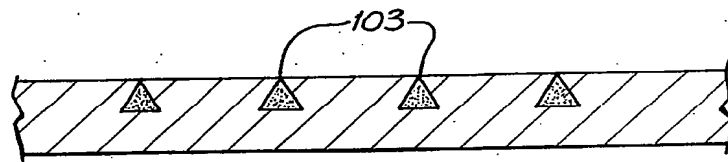
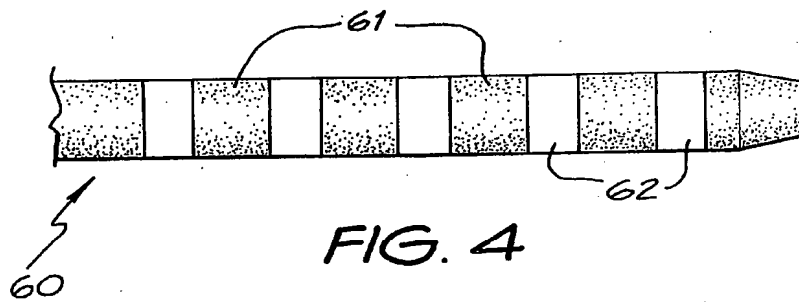
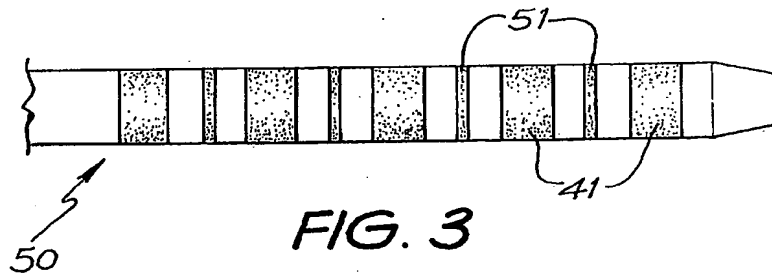
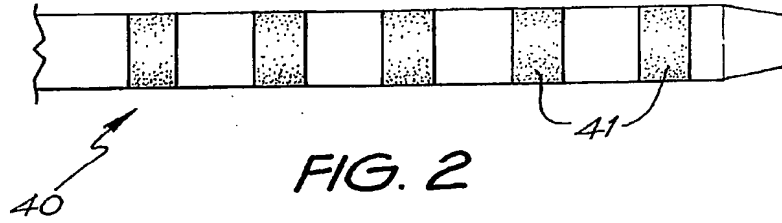

FIG. 1
PRIOR ART





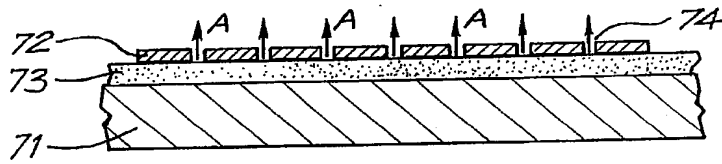

FIG. 6a

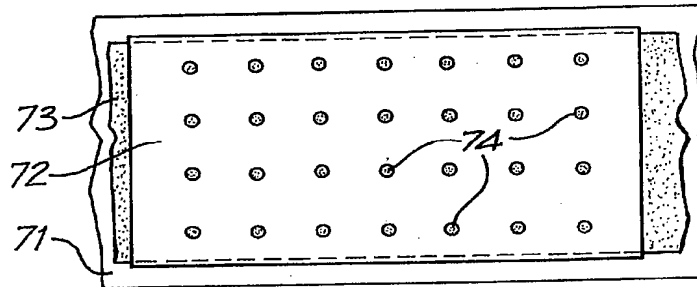

FIG. 6b

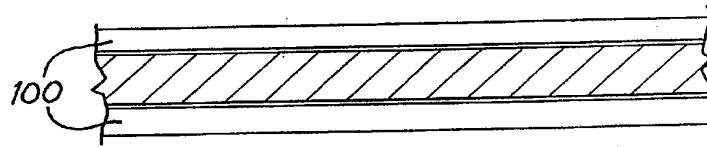

FIG. 7a

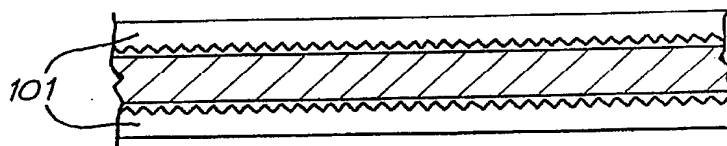

FIG. 7b

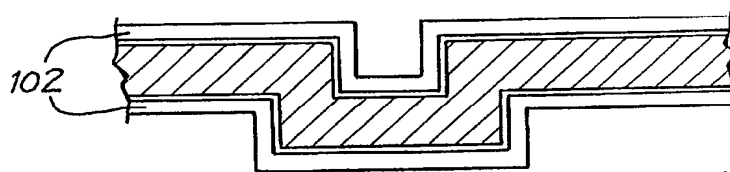

FIG. 7c

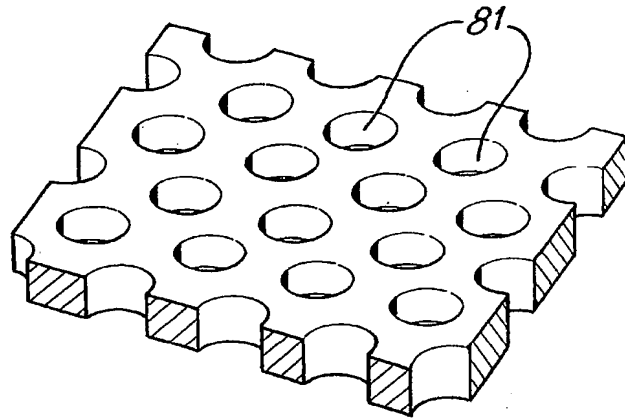

FIG. 8

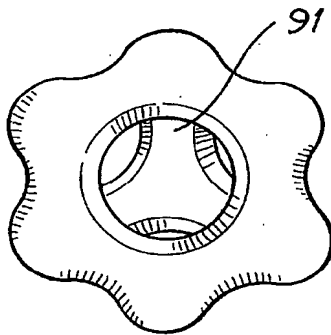

FIG. 9

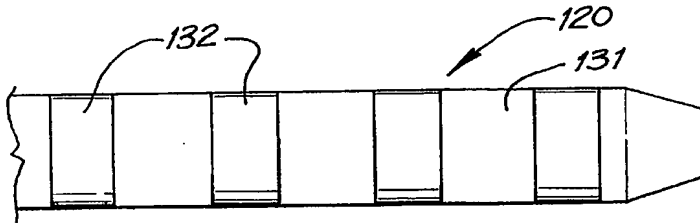

FIG. 10a
PRIOR ART

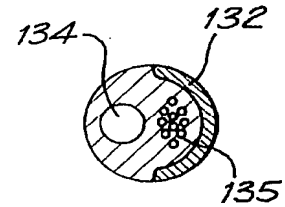

FIG. 10b

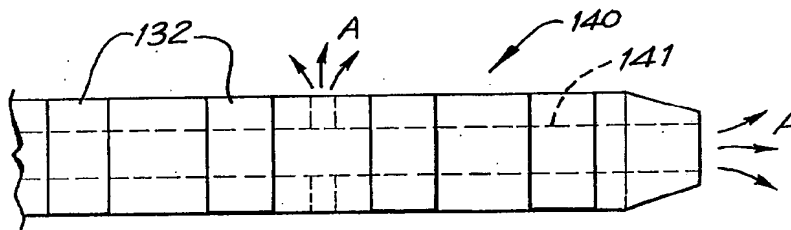

FIG. 11

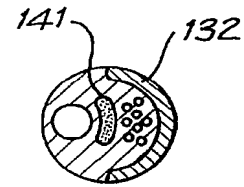

FIG. 11a

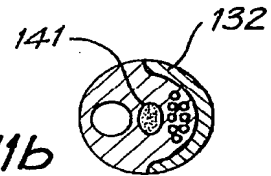

FIG. 11b

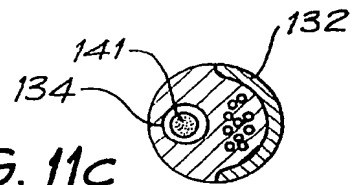

FIG. 11c

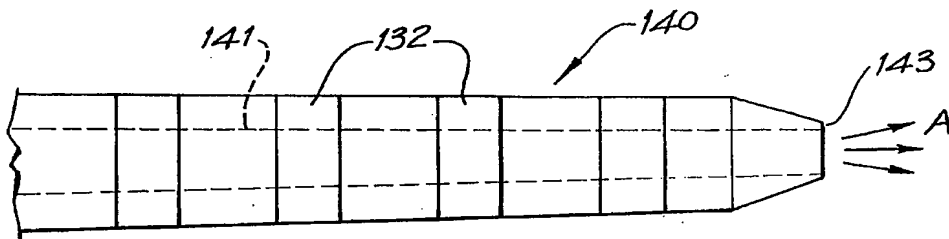

FIG. 12

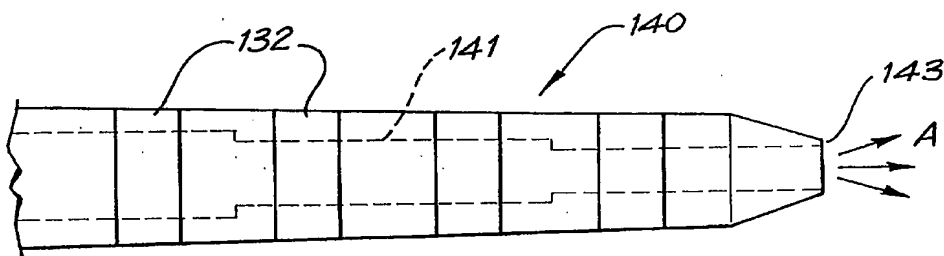

FIG. 13

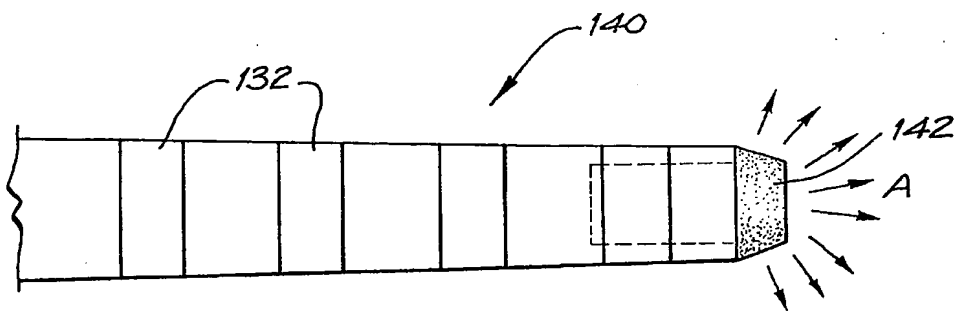

FIG. 14

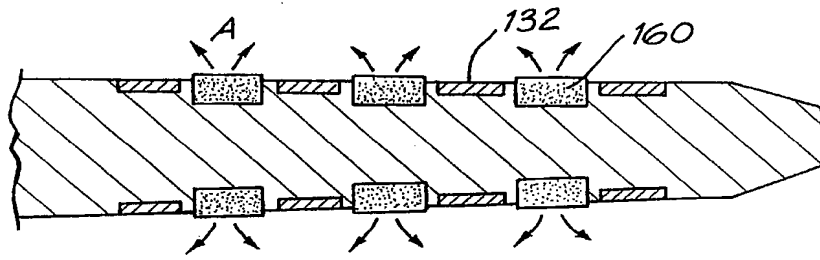

FIG. 15

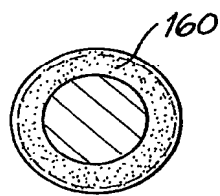

FIG. 16a

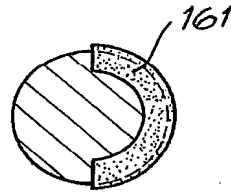

FIG. 16b

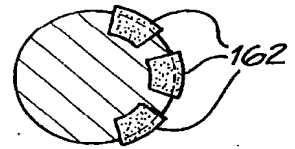

FIG. 16c

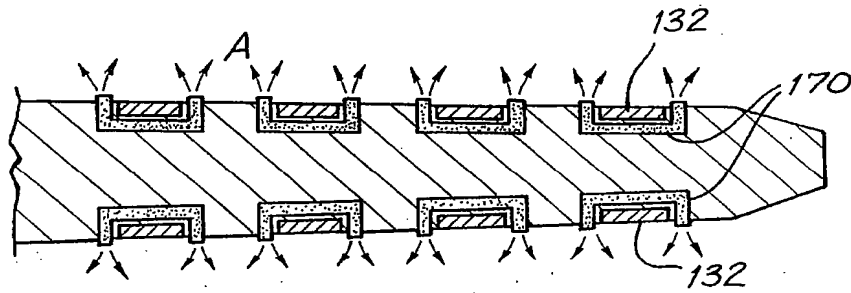

FIG. 17

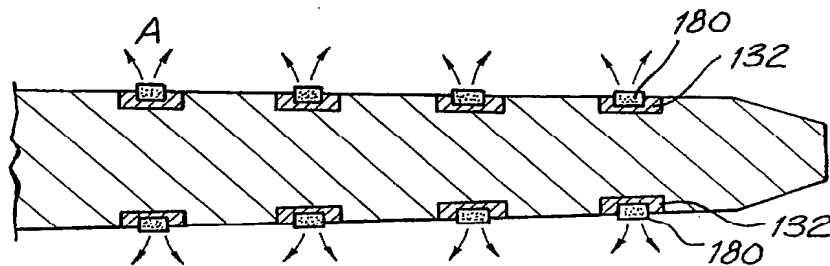

FIG. 18

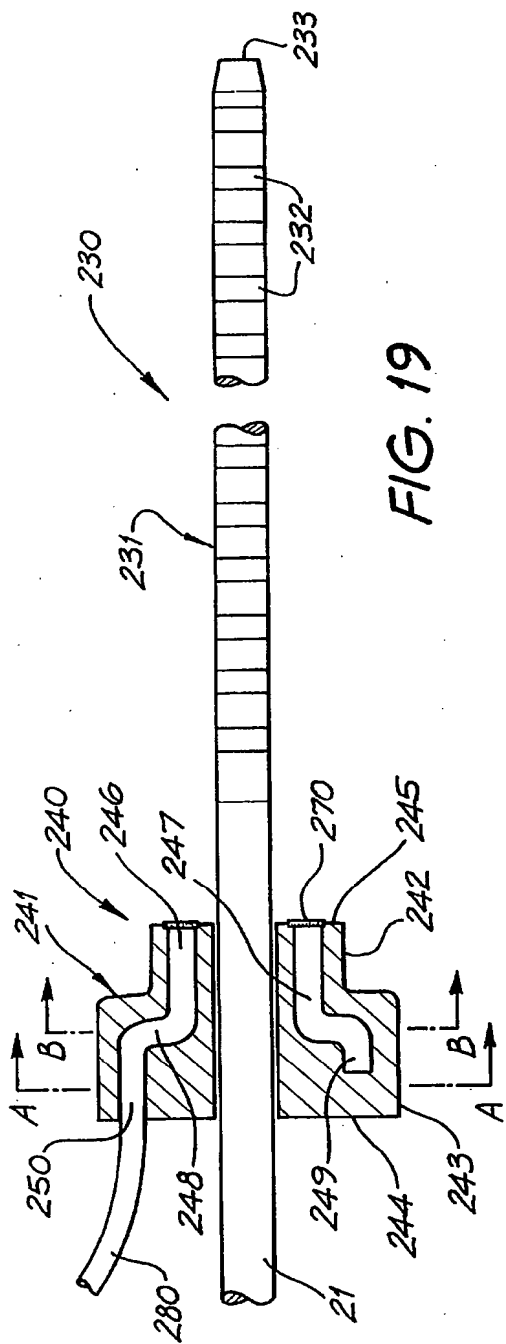

FIG. 19

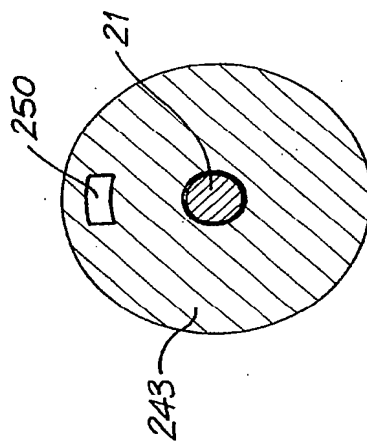

FIG. 19a

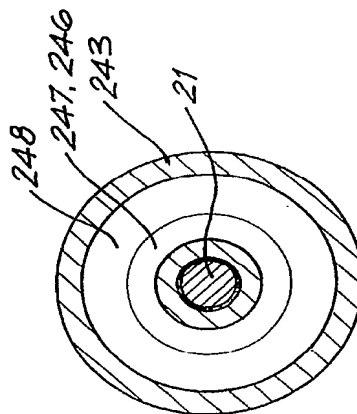

FIG. 19b

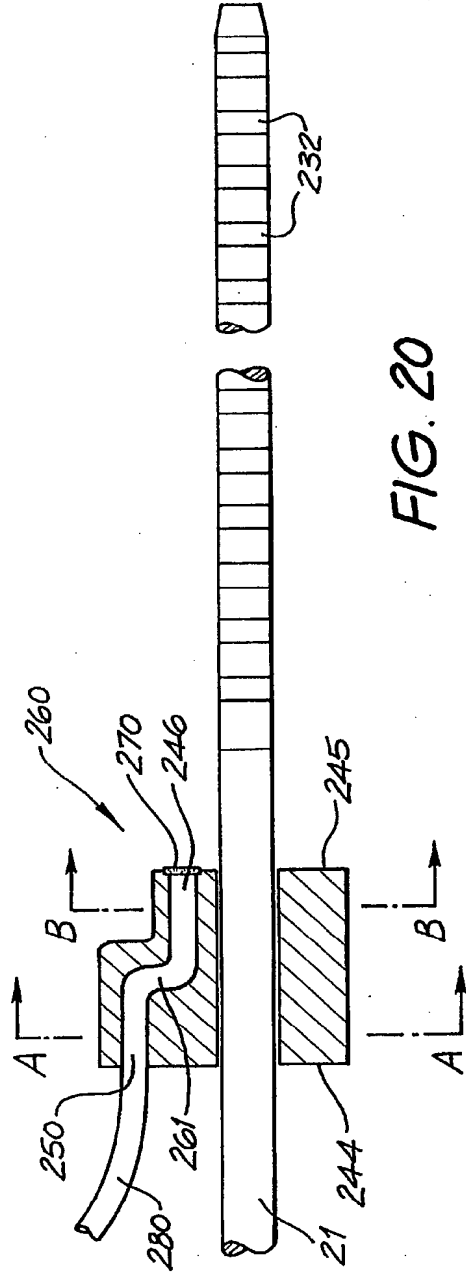

FIG. 20

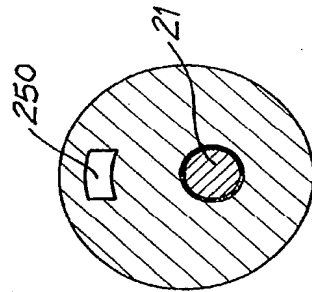

FIG. 20a

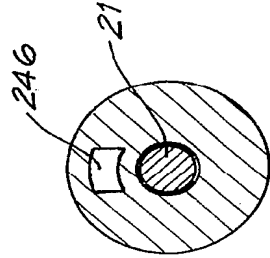

FIG. 20b